

**1** 8" P.C. CONCRETE PAVEMENT SECTION  
HEAVY DUTY AREA SCALE: N.T.S.

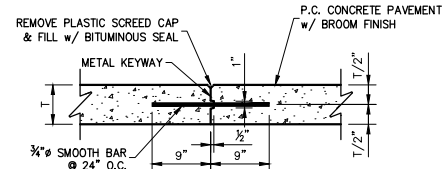

**5** TYPICAL CONTRACTION JOINT "C" - ALT 1  
P.C. CONCRETE PAVEMENT SCALE: N.T.S.

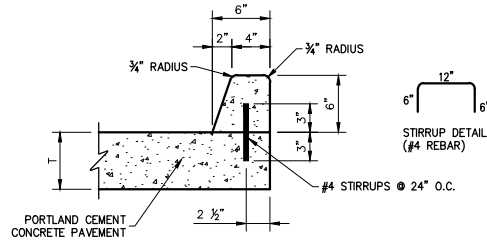

**9** 6" P.C. CONCRETE BARRIER CURB  
P.C. CONCRETE PAVEMENT SCALE: N.T.S.

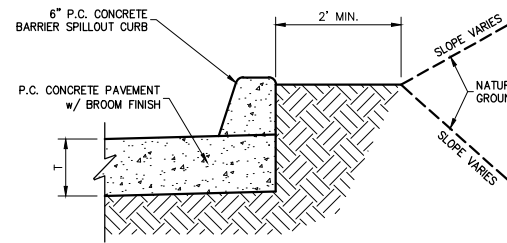

**13** BACK OF CURB GRADING DETAIL  
SCALE: N.T.S.

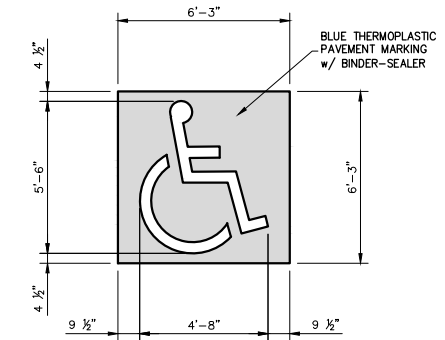

**17** ADA STANDARD PARKING PAVEMENT SYMBOL  
THERMOPLASTIC BLUE SYMBOL SCALE: N.T.S.

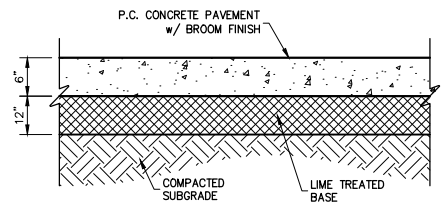

**2** 6" P.C. CONCRETE PAVEMENT SECTION  
MEDIUM DUTY AREA SCALE: N.T.S.

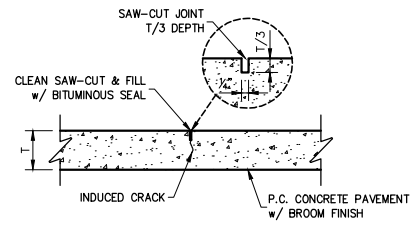

**6** TYPICAL CONTRACTION JOINT "C" - ALT 2  
P.C. CONCRETE PAVEMENT SCALE: N.T.S.

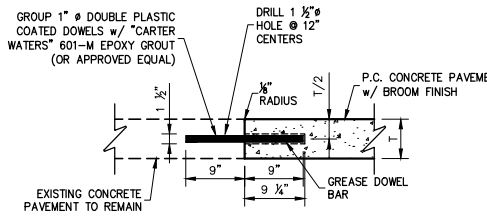

**10** TYPICAL TIE TO EXISTING CONCRETE PAVEMENT - ALT 1  
P.C. CONCRETE PAVEMENT SCALE: N.T.S.

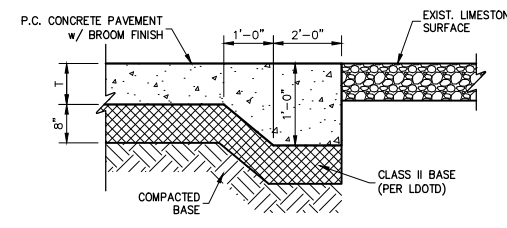

**14** LIMESTONE AND CONCRETE PAVEMENT SECTION/CONNECTION  
PARKING AREA SCALE: N.T.S.

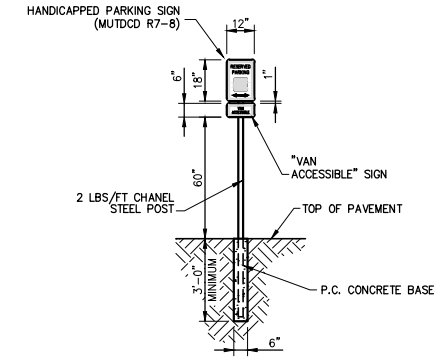

**18** HANDICAPPED PARKING SIGN  
(VAN ACCESSIBLE) SCALE: N.T.S.

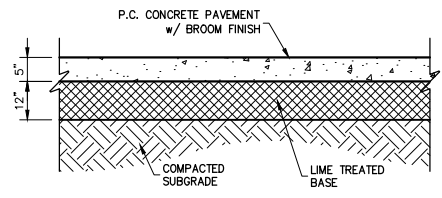

**3** 5" P.C. CONCRETE PAVEMENT SECTION  
PARKING AREA SCALE: N.T.S.

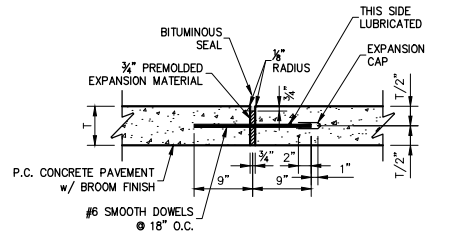

**7** TYPICAL EXPANSION JOINT "E"  
P.C. CONCRETE PAVEMENT SCALE: N.T.S.

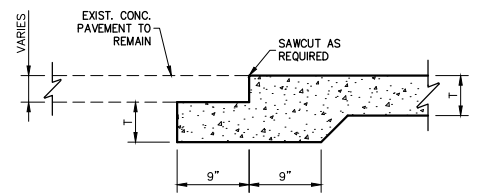

**11** TYPICAL TIE TO EXISTING CONCRETE PAVEMENT - ALT 2  
P.C. CONCRETE PAVEMENT SCALE: N.T.S.

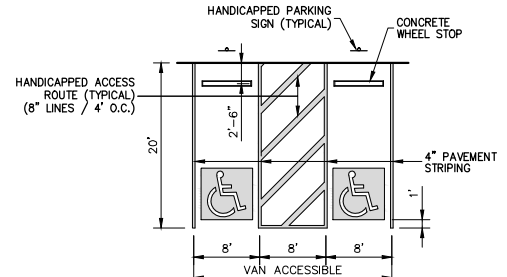

**15** TYPICAL HANDICAPPED STRIPING  
9-FT. VAN ACCESSIBLE ACCESS ROUTE SCALE: N.T.S.

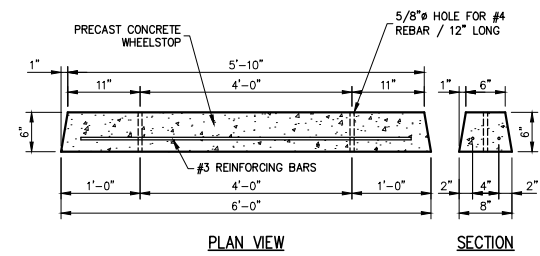

**19** PRECAST CONCRETE WHEEL STOP  
SCALE: N.T.S.

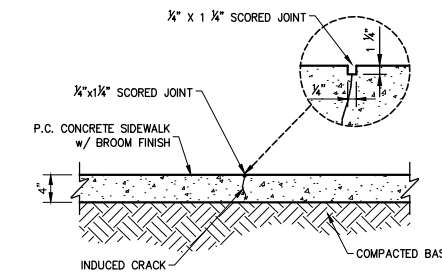

**4** 4" P.C. CONCRETE SIDEWALK SECTION  
w/ TYPICAL DUMMY (CONTROL JOINT) SCALE: N.T.S.

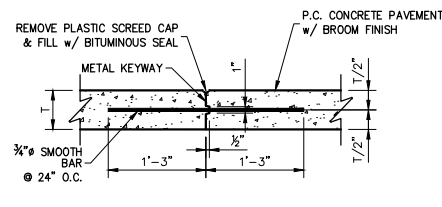

**8** TYPICAL LONGITUDINAL JOINT "L"  
P.C. CONCRETE PAVEMENT SCALE: N.T.S.

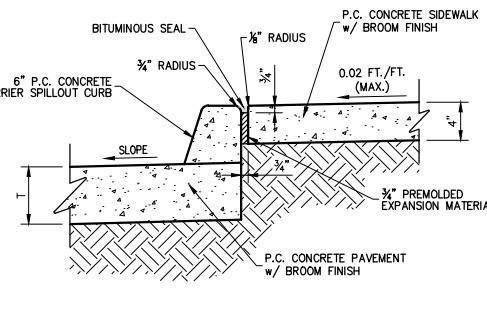

**12** TYPICAL SECTION 4" SIDEWALK / SPILLOVER CURB  
6" BARRIER SPILLOVER CURB SCALE: N.T.S.

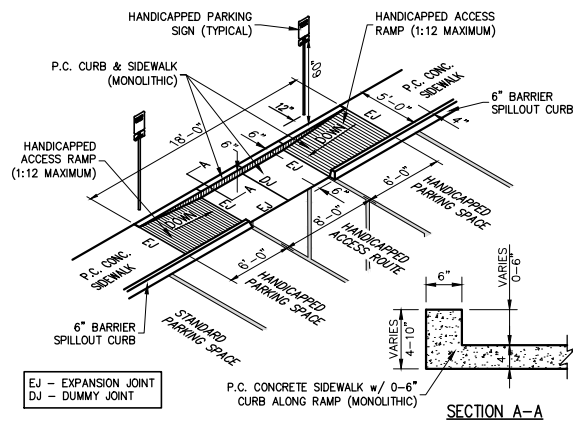

**16** HANDICAP RAMP DETAIL  
8-FT. ACCESS ROUTE WITH 5-FT. SIDEWALK SCALE: N.T.S.

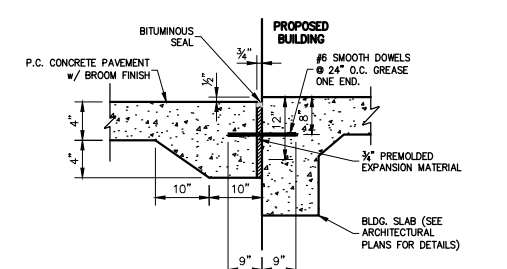

**20** CONCRETE SIDEWALK SECTION TO BUILDING SLAB CONNECTION  
ALL AREAS SCALE: N.T.S.

Client: CONCORDIS DEVELOPMENT  
BATON ROUGE, LLC  
4321 BELLEVUE BLVD.  
BATON ROUGE, LA 70809  
Project: SIEGEN LANE ASSISTED  
LIVING COMMUNITY  
BATON ROUGE, LOUISIANA

Title: DETAILS  
Description: LOCATED IN SECTION 37, TOWNSHIP 8 SOUTH, RANGE 1 EAST, GREENSBURG LAND DISTRICT, EAST BATON ROUGE PARISH, LOUISIANA  
DWG Paths: P:\14-137 Concordis Senior Living - Siegen Lane Drawings\Engineering\Plans\Current\14137\_08\_10.dwg

**QUALITY**  
Engineering & Surveying, LLC  
18350 Hwy 42 Port Vincent, LA 70726  
TEL 225-698-1600 FAX 225-698-3367  
www.QESLA.com

Stamp: DERIC J. MURPHY  
License No. 25602  
PROFESSIONAL ENGINEER  
IN  
CIVIL ENGINEERING

Date: APRIL 2016  
Project No.: 14-137  
Drawn By: DHM  
Sheet: 8 OF 15